



SB3024iL/SB3024DiL Manual

Solar Boost™ 3024(D)iL MPPT

40 A @12 V | 30 A @24 V - MAXIMUM POWER POINT TRACKING
SOLAR CHARGE CONTROLLER



BLUE SKY ENERGY
2598 FORTUNE WAY • SUITE K
VISTA, CA 92081 • USA
<https://sunforgellc.com/blue-sky-energy>

BLUE SKY ENERGY SB3024(D)iL MANUAL, REV H | 2022

This manual includes important safety instructions for the SB3024iL & SB3024DiL. Save these instructions.

Table of Contents

3 IMPORTANT SAFETY INSTRUCTIONS

4 PRODUCT DESCRIPTION

- Part Numbers and Options
- Product Certifications

5 OPERATION

- Charge Status Indicator
- Optional Digital Display
- Optional Remote Displays
- Multi-Stage or 2-Stage Charge Control for Lithium
- Multi-Stage Charge Control for Lead-Acid (Default)
 - Bulk Charge
 - Absorption (Acceptance) Charge
 - Float Charge
 - 2-Stage Charge Control
- Equalization
 - Automatic Equalization
 - Manual Equalization
- Output Current Limit
- Temperature and Output Power
- Optional Temperature Compensation
- Maximum Setpoint Voltage Limit
- Maximum Power Point Tracking (MPPT)
- Multiple Charge Controllers On The IPN Network
- Detailed Dimensional Drawing

9 INSTALLATION

- Electrostatic Handling Precautions
- Selecting PV Modules
- Solar Boost 3024 Setup
 - As Shipped Factory Default Settings
 - Restoring As Shipped Default Settings
 - Battery And PV (Panel) Voltage
 - Charge Voltage, Float Voltage & Charge Time
 - Output Current Display
- Battery and PV (Panel) Wiring
- Electromagnetic Compatibility
- Optional Battery Temperature Sensor
- Auxiliary Output
 - Auxiliary Battery Charge
 - Load Controller
 - Dusk-to-Dawn Lighting Control
- Installing a Multi-Controller System
 - Multi-Controller Wiring And Setup
 - IPN Network
- Mounting
- Optional Accessories (IPN Remote Displays and BT Connect)

16 TROUBLESHOOTING GUIDE

20 SPECIFICATIONS AND WARRANTY

Safety Instructions

Refer installation and servicing to qualified service personnel. No user serviceable parts in this unit.

PERSONAL PRECAUTIONS

- Working in the vicinity of lead-acid batteries is dangerous. Batteries produce explosive gasses during normal operation.
- To reduce risk of battery explosion, follow these instructions and those published by battery manufacturer and manufacturer of any equipment you intend to use in vicinity of battery.
- Someone should be within range of your voice or close enough to come to your aid when you work near a lead-acid battery.
- Have plenty of fresh water and soap nearby in case battery acid contacts skin, clothing or eyes.
- Wear complete eye protection and clothing protection. Avoid touching eyes while working near battery.
- If battery acid contacts skin or clothing, wash immediately with soap and water. If acid enters eye, immediately flood eye with running cold water for at least 15 minutes and get medical attention immediately.
- NEVER SMOKE or allow a spark or flame in vicinity of battery.
- Be extra cautious to reduce risk of dropping metal tool onto battery. It might spark or short circuit battery or other electrical part that may cause explosion.
- Remove personal metal items such as rings, bracelets and watches when working with a lead-acid battery. A lead-acid battery can produce a short circuit current high enough to weld a ring or the like to metal, causing a severe burn.
- Remove all sources of power, photovoltaic and battery before servicing or installing.

CHARGER LOCATION & INSTALLATION

- This unit is designed to charge 12 V or 24 V nominal lithium, flooded, or sealed type lead-acid chemistry batteries within the range of 20 to 10,000 amp-hours. Follow battery manufacturers charging recommendations when considering this unit for use with other battery chemistry.
- This unit employs components that tend to produce arcs or sparks. NEVER install in battery compartment or in the presence of explosive gases.
- This unit must be installed and wired in accordance with National Electrical Code, ANSI/NFPA 70.
- Over current protection for the battery must be provided externally. To reduce the risk of fire, connect to a circuit provided with 50 A maximum branch-circuit over current protection in accordance with National Electrical Code, ANSI/NFPA 70.
- Over current protection for the auxiliary load control output or auxiliary battery charge output must be provided externally. To reduce the risk of fire, connect to load or auxiliary battery with 25 A maximum over current protection in accordance with National Electrical Code, ANSI/NFPA 70.
- Insure that unit is properly configured for the battery being charged.
- Unit is not water tight. Do not expose to rain or snow.
- Insure all terminating connections are clean and tight. Battery and PV compression terminals are to be tightened to 45 in-lb (5 nm). IPN Network and battery temperature sensor compression terminals are to be tightened to 2.1 in-lb (0.24 nm). Auxiliary output compression terminals are to be tightened to 6 in-lb (0.67 nm).
- Do not connect to a PV (Panel) array capable of producing greater than 32 A short circuit current for 12 V nominal PV modules, or 24 A short circuit for PV modules greater than 12 V nominal. Limit input short circuit current to 12 A if the 24 V input 12 V output mode is used.
- This unit is not provided with a GFDI (ground-fault detector/interrupter) device and must be used with an external GFDI device as required by Article 690 of National Electrical Code for the installation location.

PREPARING TO CHARGE

- Never charge a frozen battery.
- Be sure battery is mounted in a well ventilated compartment.
- Add distilled water in each cell of a lead-acid battery until battery acid reaches level specified by battery manufacturer.

Product Description

Solar Boost™ 3024iL/3024DiL is a multi-stage Maximum Power Point Tracking (MPPT) photovoltaic battery charge controller capable delivering up to 30 A or 40 A depending on PV modules and battery voltage. The auxiliary output can serve as either a 2 A auxiliary battery charger, or as a 20 A Low Voltage Disconnect (LVD) output with or without variable Dusk-to-Dawn lighting control. The SB3024 includes an IPN Network interface which allows multiple charge controllers to communicate with each other and operate as a single charging unit.

Part Numbers and Options

SB3024iL	Solar Boost 3024iL charge controller
SB3024DiL	Solar Boost 3024iL charge controller with volt/amp display
IPNPRO	IPN ProRemote display & battery monitor
930-0022-20	Battery temperature sensor
IPNPRO-S	IPN ProRemote with required 500 A / 50 mV current shunt
IPNREM	IPN Remote display
BT Connect	Bluetooth adaptor
ProTouch	3.5" Touch-Screen display
Upgrade DUO	DUO-Option Software

Product Certifications



CONFORMS TO:

UL STD. 1741

CERTIFIED TO:

CAN/CSA STD. E335-1/2E

CONFORMS TO:

EN 61326-1:2006 ^(*)

EN 60335-1:2002 + A11:2004 + A1:2004 ^(*)

EN 60335-2-29:2004 ^(*)

FCC CFR 47 Part 15 Subpart B ^(*)

This device complies with part 15 of the FCC rules. Operation is subject to the following two conditions:

1) This device may not cause harmful interference, and 2) This device must accept any interference received, including interference that may cause undesired operations.

COVERED UNDER ONE OR MORE OF THE FOLLOWING US PATENTS

6,111,391 • 6,204,645

^(*) See Electromagnetic Compatibility at page 13.

Operation

Charge control and MPPT operation are fully automatic. At night, when PV (Panel) power production stops, the PV array is disconnected from the battery to prevent unwanted current drain. There is a 5 second turn-on delay, and a 45 second turn-off delay.



NOTE: The SB3024 operates on battery power, not PV power. A battery must be connected with a minimum voltage of 9 V for the unit to operate.

Charge Status Indicator

Shows present charge mode and approximate battery state of charge.

Charge Off: Off



Bulk (<70% Full): Continuously On



Absorption/Acceptance (70%-95% Full): Blinking - 1 SEC ON/1 SEC OFF



Float (Fully Charged): Blinking - 0.2 SEC ON/1 SEC OFF



Equalize: Rapid Blinking - 0.2 SEC ON/0.2 SEC OFF

A charge status indicator is provided on the face of the SB3024, and on the optional remote displays. If net battery charge current is greater than about 3 to 5 A per 100 amp-hours of battery capacity the charge status indicator can provide a rough indication of battery state of charge.

Table 1

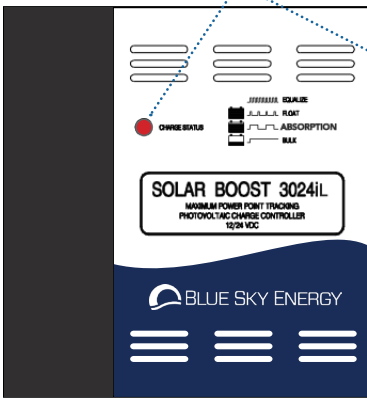

Solar Boost 3024iL

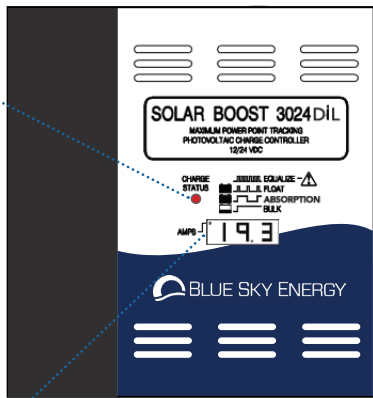

Solar Boost 3024DiL

Figure 1

AMPS Indicator: Display shows output current is when ON

Optional Digital Display, Remote Displays, and Bluetooth adapter

The SB3024DiL includes a digital display of battery voltage and output charge current. The display alternates between voltage and current when charging. Current is displayed when the “AMPS” indicator is on and can be the total of all controllers on the IPN network (factory default), or the current of a single controller on the IPN network. An automatic night time dimming feature reduces display brightness when PV (Panel) charge is OFF. The SB3024iL can be converted into a SB3024DiL by replacing the front panel with the p/n 3024PDL. Four remote displays are available. The **IPN Remote** has the same display functionality as the SB3024DiL. The full featured **IPN ProRemote** provides setup capability and enhanced monitoring of charge controllers on the IPN network. It also provides a complete battery system monitor (when utilized with external shunt) with various amp-hour counters and a highly accurate “fuel gage” type battery level indicator. The **ProTouch 3.5"** touch-screen display provides enhanced monitoring of charge controllers and setup capability by 5 preset configurations (Lead-Acid and Lithium). The **BT Connect** provides a setup capability and monitoring through detailed app (Android and iOS). See Figure 6 and Table 3 at page 16.

Multi-Stage or 2-Stage Charge Control for Lithium Battery

The SB3024 can be programmed for any type of Lithium battery via one of the following accessories: IPN ProRemote display, BT Connect, ProTouch display, or UCM. The SB3024 can also be programmed to a limited degree via its internal DIP switches. Consult the manual of the battery manufacturer for the appropriate charge profile. When programming the SB3024 for Lithium, the battery temperature compensation must be disabled and/or the Battery Temperature Sensor (p/n 930-0022-20) removed. See the manual of the specific accessory for more information.

Multi-Stage Charge Control for Sealed Lead-Acid batteries (Default)

BULK CHARGE

The SB3024 will be in Bulk charge when battery voltage is below the Absorption (Acceptance) Charge Voltage setpoint. During Bulk the SB3024 delivers as much charge current as possible to rapidly recharge the battery. Automatic current limit prevents output current from exceeding the SB3024's maximum current rating.

ABSORPTION VOLTAGE

When the battery recovers sufficient charge for voltage to rise to the Absorption Voltage setpoint, (factory set to 14.4/28.8 V) current is reduced as necessary to maintain the Absorption Voltage. The 3024 remains in Absorption until the battery is fully charged as determined by either:

- The SB3024 has remained in Absorption Voltage for the Absorption Time period (factory set to 2 hours), or
- With the IPN ProRemote display, net battery charge current while in Absorption (Acceptance) decreases to the Float Transition Current setting (factory set to 1.5 A per 100 amp-hours of battery capacity).

FLOAT CHARGE

Once the battery is fully charged, a somewhat lower Float Voltage (factory set to 13.2/26.4 V) is applied to maintain the battery in a fully charged state without excessive water loss.

2-STAGE CHARGE CONTROL

Certain battery types (including lithium) or system configurations may require 2-stage charge control. The SB3024 can be configured for two stage Bulk/Absorption charge control by setting the Float Voltage to "No Float" with the DIP switches (see figure 3) or by the IPN ProRemote, BT Connect, and the UCM. Refer to the IPN ProRemote, BT Connect, or UCM operators manual for their settings.

Equalization (only for lead-acid battery)



WARNING: Not all batteries can be safely equalized. Equalization should only be performed on vented liquid electrolyte lead-acid batteries. Always follow battery manufacturers recommendations pertaining to equalization. Equalization applies a high voltage, producing significant battery gassing. Disconnect equipment that cannot tolerate the high equalization voltage which is temperature compensated.

Periodic equalization improves battery performance and life by bringing all battery cells up to the same specific gravity and eliminating electrolyte stratification. Equalization parameters are factory set to 15.2/30.4 V for 2 hours every 30 days. A minimum net charge current of approximately 3 A per 100 amp-hours of battery capacity is required for proper equalization. If insufficient current is available equalization may have to be canceled manually since the equalization time accumulator may not complete count down.

The equalization timer is a "time at voltage" time accumulator which counts in 3 minute increments. The equalization timer will not count down unless the battery is at the equalization voltage setpoint. Unless manually disabled the SB3024 will stay in equalize for as long as necessary to accumulate the required time at voltage. If equalize does not complete by end of the charging day it will resume where it left off the next charging day, automatically canceling the equalize cycle if unable to complete in the normal manner within 24 hours.

AUTOMATIC EQUALIZATION

If DIP switch #5 is turned ON prior to the application of battery power, automatic equalization is enabled. The SB3024 will perform automatic equalization after the set number of days has elapsed. (factory set to 30 days).

MANUAL EQUALIZATION

If DIP switch #5 is turned OFF, equalization is completely disabled. A manual equalize can be performed by turning DIP switch #5 ON, after battery power is applied. Following completion of a manually initiated equalization cycle, turn DIP switch #5 OFF. If DIP switch #5 remains ON automatic equalize is enabled. Equalization can also be controlled from the IPN ProRemote, BT Connect, or UCMif DIP switch #5 is ON.

Output Current Limit

Automatic current limit prevents output current from exceeding 40 A with 12 V batteries and 12 V PV's (Panel). If PV (Panel) open circuit voltage (V_{oc}) ever exceeds 30 V which would occur with PV (Panel) voltage greater than 12 V nominal, current limit will become 30 A until the SB3024 reboots. Note that when the SB3024 exits current limit, it will briefly enter Absorption (Acceptance) on it's way back to MPPT even though battery voltage may be low.

Temperature and Output Power

When mounted vertically as described in the installation section, the SB3024 can deliver full output in an ambient temperature of up to 40 °C (104 °F). If an over temperature condition exists, the SB3024 will cycle on/off, reducing average power delivery to within safe limits. During thermal shutdown the Charge Status Indicator will display an OFF condition.

Optional Temperature Compensation (only for lead-acid battery)

The optional battery temperature sensor automatically adjusts charge voltage setpoints based on battery temperature which enhances battery performance and life, and decreases maintenance. The

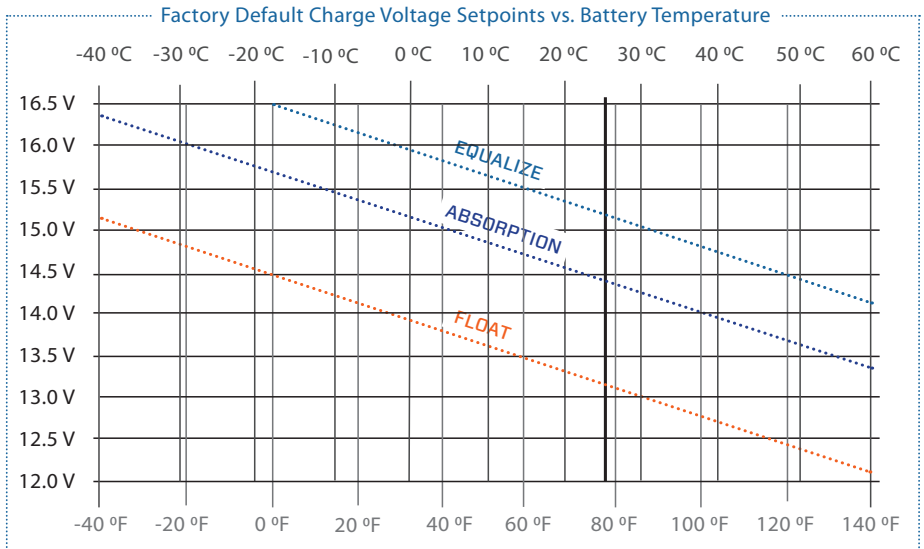

Figure 2

Maximum Setpoint Voltage Limit

Regardless of the setpoint values entered by the user or resulted from temperature compensation, the SB3024 will not apply a charge voltage setpoint greater than the maximum voltage setpoint limit (factory configured to 15.5/31.0 V). Note that actual battery voltage may briefly exceed this value by 0.1 – 0.2 V as the voltage control servo responds to changes in load.

Maximum Power Point Tracking (MPPT)

Patented MPPT technology can extract more power and increase charge current up to 30% or more compared to conventional controllers. The principal operating conditions which affect current boost performance are PV (Panel) array temperature and battery voltage. At constant solar intensity, available PV (Panel) voltage and power increase as PV (Panel) temperature decreases but it takes an MPPT controller to access this extra power. When PV (Panel) voltage is sufficiently high in Bulk for MPPT to operate, a constant power output is delivered to the battery. Since output power is constant a decrease in battery voltage produces a further increase in charge current. This means that the SB3024 provides the greatest charge current increase when you need it most, in cold weather with a discharged battery. In cool comfortable temperatures most systems see about 10 – 20% increase. Charge current increase can go to zero in hot temperatures, whereas charge current increase can easily exceed 30% with a discharged battery and freezing temperatures. For a more complete MPPT description see “What Is MPPT and how does it work?” on the FAQ page at <https://sunforgellc.com/learn-center>.

Multiple Charge Controllers on the IPN Network

The IPN network architecture allows multiple charge controllers to operate as a single charging machine. Up to 8 IPN compatible charge controllers can reside on a single network and can share a single display or battery temperature sensor. Charge controllers can be added to grow a small system into a large system and have this large system operate from the users standpoint as a single charge controller.

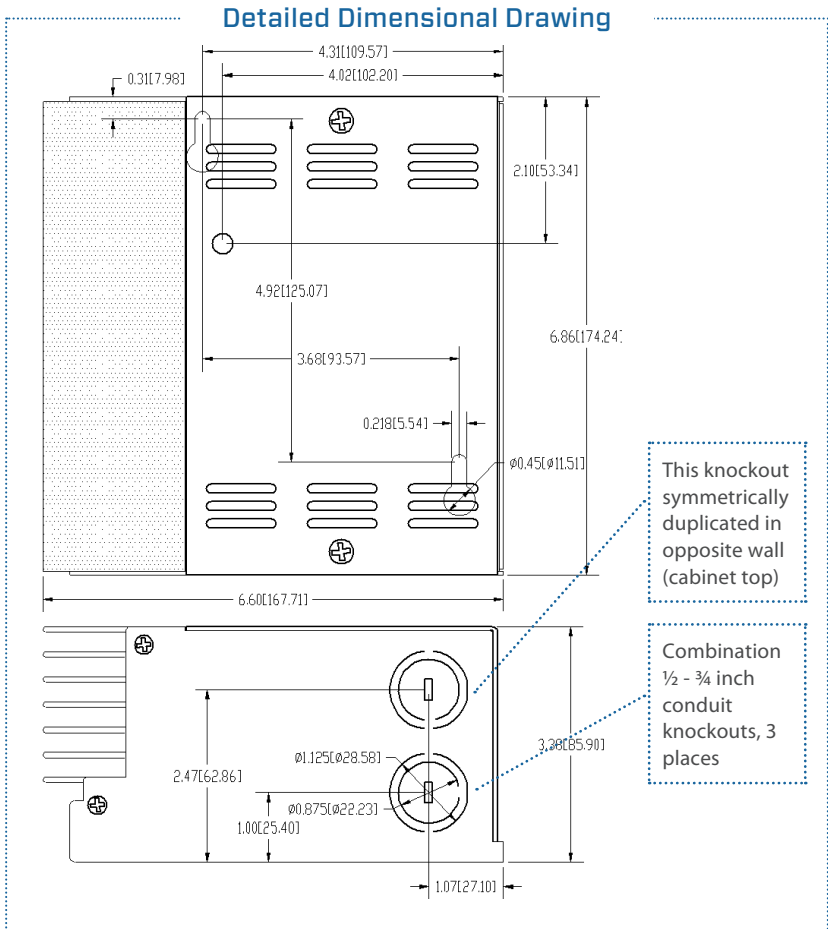

Installation



WARNING: Read, understand and follow the Important Safety Instructions in the beginning of this manual before proceeding. This unit must be installed and wired in accordance with National Electrical Code, ANSI/NFPA 70. Over current protection must be provided externally. To reduce the risk of fire, connect to a circuit provided with 40 A maximum branch-circuit over current protection (50 A with 12 V battery and 12 V PV (Panel) modules) in accordance with National Electrical Code, ANSI/NFPA 70. Do not connect a PV (Panel) array capable of delivering greater than 24 A of short circuit current I_{SC} at STC (32 A with 12 V battery and 12 V PV modules). Do not connect BAT- and PV- together external to the unit. The unit is not provided with a GFDI (ground-fault detector/interrupter) device and must be used with an external GFDI device as required by Article 690 of NEC for the installation location. To reduce risk of electric shock, remove all sources of power before installing or servicing. Figures 3, 4 and 5 show generalized connections only and are not intended to show all wiring, circuit protection and safety requirements for a photovoltaic electrical system.



CAUTION: The SB3024 is protected against reverse battery and PV (Panel) polarity, and swapped PV (Panel) and battery connections, but will be damaged by reverse battery to the PV (Panel) terminals. Transient voltage lightning protection is provided, but steady state voltage in excess of 57 VDC on the battery or PV (Panel) terminals will damage the unit. Damage of either type voids the limited warranty.

Electrostatic Handling Precautions

To minimize the likelihood of damage, discharge yourself by touching a water faucet or other electrical ground prior to handling the 3024 and avoid touching circuit board components. The risk of electrostatic damage is highest when relative humidity is below 40%.

Selecting PV Modules

Voltage, current and power produced by Photovoltaic (PV) modules fluctuate widely with operating conditions. As a result a set of test conditions referred to as Standard Test Conditions (STC) are used to rate modules in a meaningful manner and accurately predict real world performance. STC ratings are not maximum or optimal ratings. Conditions can be present where V_{OC} and I_{SC} approach 1.25 times STC ratings which is why National Electrical Code and our recommendations call for 1.25 derating of both V_{OC} and I_{SC} . Yet in real world conditions I_{MP} is commonly only about 75 – 80% of I_{MP} at STC.

Key PV module specifications

P_{MAX}	Maximum power in watts ($P_{MAX} = V_{MP} \times I_{MP}$)
V_{OC}	Voltage with module open circuit (typically about 20–22 V for 12 V nominal 36 cell modules)
V_{MP}	Voltage where module produces Maximum Power (typically about 17–18 V for 12 V nominal 36 cell modules)
I_{MP}	Current where module produces Maximum Power
I_{SC}	Current with module Short Circuit

The SB3024 will provide the best MPPT current boost performance if all PV (Panel) modules are identical. If module types are mixed, do not put dissimilar modules in series. Dissimilar modules in parallel should have V_{MP} values within about 0.5 V or better for 12 V modules, and be of the same basic cell technology so their V_{MP} will tend to track as operating conditions change. If module types are very different consider using a separate charge controller for each module type to obtain the best MPPT current boost performance.

Select PV (Panel) modules that do not exceed the maximum ratings shown below, and preferably produce at least 3 A of I_{MP} per 100 amp-hours of battery capacity.

Nominal Battery Voltage	Automatic Current Limit	Max PV Power @ STC	Max PV I _{sc} @ STC	Max PV V _{oc} @ STC	Recommended range of V _{MP} at STC		
					Nominal 12V PV	Nominal 18V PV	Nominal 24V PV
12 V	40 A*	540 W	32 A*	24.0 V*	16.5 / 18.5 V	-	-
12 V	30 A	400 W	16 A	45.6 V	-	24.8 / 27.8 V	-
12 V	30 A	400 W	12 A	45.6 V	-	-	33.0 / 37.0 V
24 V	30 A	800 W	24 A	45.6 V	-	-	33.0 / 37.0 V

(*) Current rating and current limit are 40 A when charging a 12 V battery from nominal 12 V PV (Panel) modules. If PV (Panel) V_{oc} ever exceeds 30 V (>12 V nominal PV modules) current rating and current limit become 30 A.



NOTE: The SB3024 has various setup parameters all of which are preconfigured at the factory. Confirm that the SB3024's charge parameter settings are within the ranges specified by the battery manufacturer. Default settings are typically suitable for most flooded or sealed lead-acid batteries and likely require no changes. For lithium battery, check the charge settings recommended by the manufacturer.

Setup parameters are divided into two categories, **Basic** and **Advanced**. Basic parameters can be configured with the SB3024 alone within limited steps and ranges as shown in Figure 3. Advanced parameters require the IPN ProRemote, UCM, or BT Connect to access. The IPN ProRemote, BT Connect, and UCM also allows basic settings to be configured in smaller steps and over wider ranges. All setup parameters are retained if power is lost, or the IPN ProRemote/BT Connect/ProTouch/UCM is used as a setup tool only and removed.

As-Shipped Factory Default Settings

Basic Settings	Charge mode	3-stage
	Absorption (Acceptance) voltage	14.4/28.8 V
	Float voltage	13.2/26.4 V
	Charge time	2.0 hours
	Equalize	Disabled
	IPN Network address	0 (zero)
	Auxiliary Output mode	Aux. bat. charger
	All DIP switches	OFF
Current display (SB3024DiL)		IPN network total
Advanced Settings	Equalize voltage	15.2/20.4 V
	Equalize time	2.0 hours
	Auto equalize days	30 days
	Maximum voltage setpoint limit	15.5/31.0 V
	Float Transition Current	1.5 A/100 amp-hours
	Temperature compensation factor	-5.00 mV/°C/cell
	Load control ON voltage	12.6/25.2 V
	Load control OFF voltage	11.5/23.0 V
Dusk-to-Dawn lighting control	Disabled	

RESTORING AS-SHIPPED DEFAULT SETTINGS

1. Remove PV (Panel) and battery power.
2. Turn **ALL 8** power board DIP switches shown in Figure 3 ON.
3. Restore battery power for 10 seconds, then remove battery power.
4. Return **ALL 8** power board DIP switches to their default OFF position.
5. If display is present, set display DIP's to #4 ON, #1-3 OFF
6. The unit is now set to as shipped factory default settings.

BATTERY AND PV VOLTAGE



NOTE: Nominal battery and PV (Panel) voltage are determined automatically. The battery is considered to be 12V if battery voltage when first connected is less than 16V, or 24V if battery voltage is greater. PV (Panel) voltage is also determined automatically. If nominal PV (Panel) voltage is changed following installation power must be momentarily removed to reboot the SB3024.

ABSORPTION VOLTAGE, FLOAT VOLTAGE, & ABSORPTION TIME

Absorption Voltage, Float Voltage and Absorption Time setpoints can be viewed or changed using the parameter setup LED's and DIP switch shown in Figure 3. Operate only one switch at a time. To view the present setting turn the appropriate DIP switch ON momentarily (AbsV #8, FloatV #6, or AbsT #7). For a 24 V battery the actual voltage setpoints are doubled.

To change a setting, turn the appropriate DIP switch ON, OFF, and then back ON before the LED's turn OFF. The SB3024 will enter setup mode and scan through available settings. Turn the DIP switch off at the desired setting to store the new value. If Float Voltage is set to "No Float" the SB3024 operates as a two stage charger, will remain in Absorption, and will not display Absorption Time on the setup LED's. For more details, visit the Learning Center page at <https://sunforgellc.com/learning-center/> and watch the video "Solar Boost 3024iL Basic Settings".

Setup and Wiring Diagram

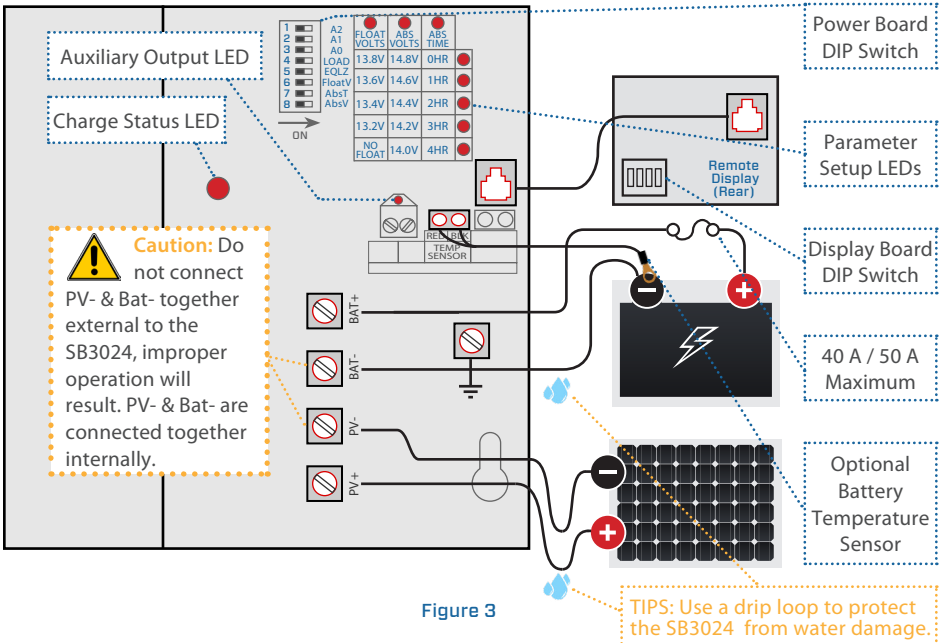

Figure 3

OUTPUT CURRENT DISPLAY (SB3024DiL ONLY)



NOTE: The display can show total output current from all networked controllers, or the output current of a single controller. To show output current from a single controller IPN network address of the display and charge controller must match.

DISPLAY BOARD DIP SWITCH	IPN ADDRESS – OUTPUT CURRENT OF SINGLE CHARGER UNIT								TOTAL OUTPUT CURRENT OF ALL CHARGERS ON IPN NETWORK
	0	1	2	3	4	5	6	7	
# 1 (A2)	OFF	OFF	OFF	OFF	ON	ON	ON	ON	Don't care
# 2 (A1)	OFF	OFF	ON	ON	OFF	OFF	ON	ON	Don't care
# 3 (A0)	OFF	ON	OFF	ON	OFF	ON	OFF	ON	Don't care
# 4 (IPN Total)	OFF	OFF	OFF	OFF	OFF	OFF	OFF	OFF	ON

Table 2

Battery and PV (Panel) Wiring



CAUTION: Battery and PV (Panel) compression terminals accept #14–2 AWG wire and are tightened to 45 in-lb (5 nm). IPN network compression terminals accept #24–14 AWG wire and are tightened to 2.1 in-lb (0.24 nm). Auxiliary Output compression terminals accept #24–12 AWG wire and are tightened to 6 in-lb (0.67 nm).

DO NOT connect Bat– and PV– together external to the SB3024 or improper operation will result. Bat– and PV– connect together internally.

A desirable installation would produce a total system wiring voltage drop of 3% or less. The lengths shown in Table below are one way from the PV to the battery with the SB3024 located along the path. Wire length can be increased inversely proportional to actual current. If current was reduced by 1/2, wire lengths could doubled and still provide 3% voltage drop.

Maximum Conductor Pair Length - 3% Voltage Drop

Wire Gauge AWG	12 Volt System @ 32 A FEET/METERS	24 Volt System @ 24 A FEET/METERS
12	4.0 / 1.2	10.7 / 3.3
10	6.4 / 2.0	16.9 / 5.2
8	10.1 / 3.1	26.9 / 8.2
6	16.1 / 4.9	42.8 / 13.0
4	25.5 / 7.8	68.1 / 20.7
2	40.6 / 12.4	108.2 / 33.0
1/0	64.6 / 19.7	172.2 / 52.5

Electromagnetic Compatibility

To comply with electromagnetic compatibility requirements the SB3024's battery and PV (Panel) wiring must be installed in grounded metallic conduit, and the two clamp on type ferrite suppressors supplied must be installed. Clamp one suppressor around both Bat+ and Bat– cables. Clamp the second suppressor around both the battery temperature sensor and remote display cables with the cables looped to pass through the core 3 times.

If both sensor and display cables are used, the sensor cable outer cover must be stripped back ~12 inches (30 cm) so both cables will fit through the core 3 times. Ensure that the two suppressors are restrained so they will not damage circuit board components. Additional suppressors can be ordered as p/n 523-0005-01.

Optional Battery Temperature Sensor (only for lead-acid battery)

Installation of the optional battery temperature sensor enables temperature compensation of all charge voltage setpoints in order to improve performance and extend the battery longevity. In a multi-controller system a single temperature sensor must connect to the IPN master. Do not attach sensors or components other than the Blue Sky Energy battery temperature sensor (p/n 930-0022-20) to the temp sensor terminal block. Be certain to observe proper RED/BLK polarity.

Auxiliary Output

The auxiliary output can serve one of three functions; 1) a 2 A auxiliary battery charger, 2) a 20 A load controller with Low Voltage Disconnect (LVD), or 3) a 20 A variable Dusk-to-Dawn lighting load controller with Low Voltage Disconnect (LVD). The Charge/Load function is selected by DIP switch #4 shown in Figure 3. The IPN ProRemote, BT Connect, or UCM is required to adjust LVD thresholds or enable Dusk-to-Dawn lighting control. Auxiliary outputs in a multi-controller system will function normally, but only the auxiliary output in the master can be configured or monitored using the IPN ProRemote. The auxiliary output "Load" LED will illuminate whenever the auxiliary output is ON (*).



NOTE (*): The LOAD indicator light will be ON whenever power is available at the Load and Auxiliary Battery Charge terminals.

Auxiliary Output Wiring

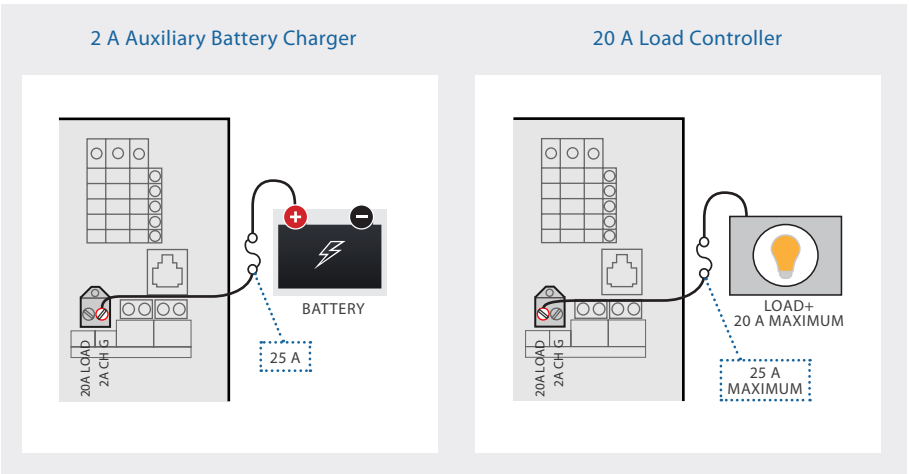

Auxiliary Output Equivalent Circuit

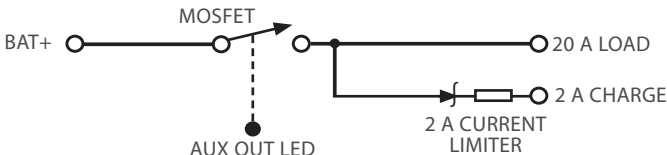

Figure 4



CAUTION: The auxiliary output cannot perform both auxiliary battery charge and load control functions at the same time. Do not connect to the 20 A Load terminal for auxiliary battery charge.

AUXILIARY BATTERY CHARGE – DIP #4 OFF

The auxiliary charge function is used to charge an auxiliary battery of the same voltage as the primary battery. If the primary battery is charging in Absorption (Acceptance) or Float, up to 2 A is diverted to the auxiliary battery at roughly the same charge voltage. Auxiliary battery charge is disabled during bulk or equalization. Use 14 AWG wire to minimize voltage drop and 25 A over current protection. Auxiliary battery negative must connect to primary battery negative.

LOAD CONTROLLER – DIP #4 ON

The load controller can deliver up to 20 A (increased to 70 A w/ the CBM4070) of continuous output from the battery. Default settings are for LVD operation with ON at $V_{BAT} \geq 12.6/25.2$ V, and OFF at $V_{BAT} \leq 11.5/23.0$ V, which can be changed using the IPN ProRemote, BT Connect, or UCM. Operation can also be based on net battery amp-hours if an IPN ProRemote (with external shunt) is present. The ON/OFF condition must be valid for 20 seconds before switching will occur. If the higher/lower values are reversed the output control logic is inverted. Load negative must connect to battery negative.



CAUTION: 25 A maximum over current protection for load control output must be provided externally. If the load control output is configured to operate based on net battery amp-hours, configure ON/OFF voltage thresholds as well. If amp-hour from full data is not available, voltage based operation will resume. Voltage or amp-hour ON/OFF thresholds must not be the same value or improper operation will result.

DUSK-TO-DAWN LIGHTING CONTROL – DIP #4 ON

A BT Connect, or UCM, or IPN ProRemote with software version V2.00 or later is required to enable lighting control. Refer to the operators manual for lighting control setup instructions. Variable time settings are available to turn lighting ON after Dusk (Post-Dusk timer) and/or ON before Dawn (Pre-Dawn timer). If both timers are set to DISABLED (factory default), the lighting control feature is disabled. If either the Post-Dusk or Pre-Dawn timers are set to a time value the lighting control feature is enabled. When lighting control is enabled the auxiliary output is controlled by both the normal load (LVD) control function and the lighting control function such that whichever function wants the auxiliary output OFF prevails.

Dusk or night time begins when the charge control system turns OFF, which occurs when PV (Panel) module current drops below about 50 mA at battery voltage. Dawn or day time begins when the charge control system turns ON which occurs when PV module current rises to about 100 mA at battery voltage. If the Post-Dusk timer was set to 1.0 hour and the Pre-Dawn timer was set to 2.0 hours, lights would turn ON at Dusk, remain ON for one hour, and then turn OFF. Two hours before Dawn the lights would again turn ON and remain ON until Dawn. For full Dusk to Dawn lighting set the Post-Dusk timer to 20 hours. Lights will always be OFF when the charge control system is ON.

When the SB3024 first receives battery power it does not know when Dawn is expected to occur. As a result, Pre-Dawn control does not operate for the first night. Once a night time period of 4 hours or more is detected, this night time period is stored and Pre-Dawn control will operate. Each subsequent night time period greater 4 hours is added to a filtered average of night time.

Installing a Multi-Controller System

A communication link is established between controllers by daisy chaining a twisted pair cable from the IPN Network terminal block, controller to controller (A-to-A, B-to-B) as shown in Figure 5. Up to 8 IPN based charge controllers can be connected together in a multi-controller system. Device address 0 (zero) is the master and 1 – 7 are followers. The master controls the charging process and directs the activities of the followers. The charge control system will start whenever one or more controllers receives PV (Panel) input power.

MULTI-CONTROLLER WIRING AND SETUP



CAUTION: A multi-controller system requires the following specialized installation and setup:

1. Each controller must connect to and charge the same battery or batteries.
2. One controller must be set to IPN address 0 (zero) and the others be set to addresses 1 – 7 with no controllers set the same.
3. Charge parameters are set in the master only.
4. While outputs connect in parallel to a common battery, PV (Panel) inputs must be completely separate, with separate PV+ and PV- wiring.
5. All controllers must be connected to the IPN network as shown in the wiring figure.

IPN Network Wiring

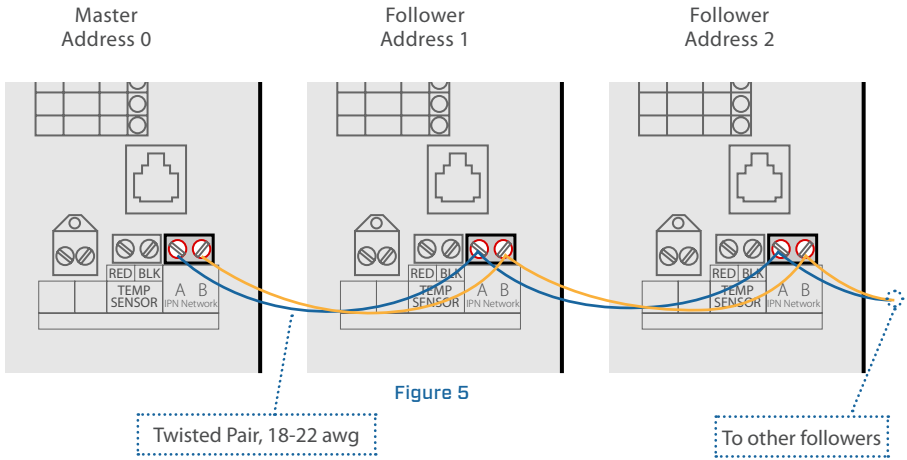

IPN NETWORK ADDRESS



NOTE: A single controller must be set to IPN network address 0 (zero). In a multi-controller system one controller must be set to address 0 (zero) to serve as the master. The other controllers must be set to address 1-7 with no two controllers set the same.

POWER BOARD DIP SWITCH	MASTER		FOLLOWERS					
	0	1	2	3	4	5	6	7
# 1 (A2)	OFF	OFF	OFF	OFF	ON	ON	ON	ON
# 2 (A1)	OFF	OFF	ON	ON	OFF	OFF	ON	ON
# 3 (A0)	OFF	ON	OFF	ON	OFF	ON	OFF	ON

Mounting



CAUTION: Mount the unit with heatsink fins oriented vertically to promote cooling and do not enclose in a confined space. The SB3024 is not waterproof and must be protected from rain, snow and excessive moisture.

Installing Optional Accessories (Remote Displays and BT Connect)

The SB3024iL/DiL can communicate via IPN cable with different accessories for full monitoring and advanced programming. More accessories with different capabilities can be connected simultaneously to the SB3024 via RJ-11 cables (see Figure 6), as for example, a remote display (IPN Remote, IPN ProRemote, or ProTouch), the Bluetooth adapter BT Connect, and the UCM. See Table 3.

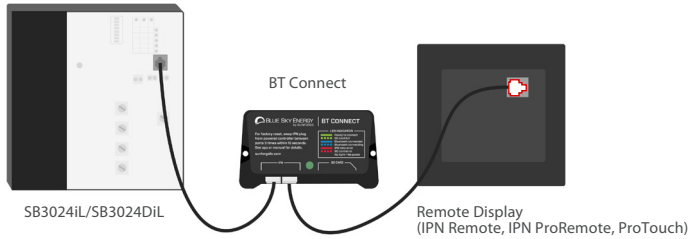

Figure 6

	IPN Remote	IPN ProRemote	ProTouch	BT Connect
Description:	1-Line LED Display	2-Line LCD Display	3.5" Touch-Screen Display	Bluetooth Adapter
Monitoring:	Basic	Full	Full	Full w/ historical graphs
Programming:	-	Full	5 Preset Charge Profiles	Full
Interface:	RJ-11	RJ-11	RJ-11	RJ-11, Bluetooth
Mounting:	Flush Mounting	Flush Mounting	Flush Mounting	Surface Wall Mounting

Table 3

Troubleshooting Guide

Symptom	Probable Cause	Item to Examine or Correct
Completely dead, no display	No battery power	Battery disconnected, overly discharged (<9 V), or connected reverse polarity. Battery powers unit, not PV (Panel).
Unit will not turn on (charge status LED off), Display if present may be OK	PV (Panel) disconnected	PV (Panel) must supply at least 0.15 A at just above battery voltage to begin charge.
	PV reverse polarity	Reverse polarity PV will cause heat sink to heat.
	IPN network address set wrong	A single unit must be set to IPN network address 0 (zero). One unit of a multi-unit network must be set to IPN network address 0 (zero), AND all other units must be set to different addresses.
	Low battery power	Battery overly discharged (<9 V). Battery powers unit, not PV (Panel).
Unit cycles on/off	Extreme voltage fluctuations or interference has caused microprocessor lock-up	Reboot microprocessor by momentarily removing all power. Reattach power crisply.
	PV- connected to BAT- external to unit	PV- & BAT- must be separate external to the unit for proper operation and cannot connect to a common location. External connection prevents proper operation of internal shunts and current measurement system.

Charge status LED on, but no output charge current	Battery voltage greater than charge voltage setpoint	This is normal operation. Output is off due to high battery voltage which may be caused by other charging systems.
	Battery voltage too low	Battery voltage must be at least 9 V for the unit to operate.
	Unit recognized battery voltage to be 12 V when it is actually 24 V	Battery voltage is determined automatically when the unit first receives power. Voltage must be greater than 16 V to recognize battery as 24 V. Remove all power, and reapply battery quickly and crisply.
Charge status LED blinks rapidly	System in equalize mode	Disable equalize via IPN ProRemote, or by turning DIP switch #5 off.
Charge current is lower than expected, PV current may be low as well	Battery is highly charged	Normal operation, current is reduced if battery voltage is at setpoint.
	Worn out PV modules	Replace, or use as is.
	Low insolation	Atmospheric haze, PV's (Panel) dirty, sun low on horizon, etc.
	PV- connected to BAT-	PV- & BAT- must be separate external to the unit for proper operation and cannot connect to a common location. External connection prevents proper operation of internal shunts and current measurement system.
	Nominal PV (Panel) voltage has changed from 18 V or 24 V to 12 V	If PV (Panel) voltage is changed to 12 V, all power must be removed momentarily to reboot unit and load initial PV (Panel) control values.
	Current limit has switched to 30 A	Normal operation. Current limit will change to 30 A if $PV V_{oc}$ has exceeded 30 V which will occur with greater than 12 V nominal PV's. Reconfigure PV's for 12 V and reboot SB3024 to resume 40 A current limit.
MPPT Current boost is less than expected	PV (Panel) maximum power voltage (V_{MP}) is not much higher than battery voltage, leaving little extra power to be extracted	PV's with low V_{MP} . PV's with higher VMP produce greater power and current boost potential. PV's with $V_{MP} \geq 17 V$ work best.
		Excessive PV (Panel) wiring voltage drop due to undersize wiring, poor connections etc.
		Battery is nearly charged and battery voltage is high. Output during MPPT operation is "constant power", higher battery voltage reduces charge current increase.
	PV's hot	VMP and available power decrease with increasing PV cell temperature. Cooler PV's will produce greater boost. It is normal for boost to decrease as temperature rises.
	Nominal PV (Panel) voltage has changed from 18 V or 24 V to 12 V	If PV (Panel) voltage is changed from to 12 V, all power must be removed momentarily to reboot unit and load initial PV (Panel) control values.
Auxiliary battery not charging (Cont'd...)	Auxiliary output not configured for auxiliary battery charge	Confirm dip switch #4 is OFF.

(Cont'd) Auxiliary battery not charging	Primary battery not highly charged	Auxiliary battery will not receive charge unless primary battery is highly charged in Absorption (Acceptance) or Float.
	Load on Auxiliary battery too high	Maximum auxiliary charge current is roughly 2 A. Load may need to be reduced.
System appears OK, but will not correctly switch between Bulk, Absorption (Acceptance) & Float	Not set for 3 stage charge	Check Float voltage setpoint.
	System will not switch out of Bulk and into Absorption (Acceptance) or Float	Battery is highly discharged or very large relative to relative to available net charge current. PV (Panel) power may be too low or loads too high.
	System will not switch from Float to Bulk or Absorption (Acceptance)	Normal operation. Unit will stay in Float and not switch to Bulk or Absorption (Acceptance) until it is unable to hold the battery at the Float voltage setpoint.
	System will not switch from Absorption (Acceptance) to Float	Battery not fully charged. Unit will not switch to Float until battery voltage remains at the Absorption (Acceptance) voltage setpoint continuously for the Charge Time period (or net battery current drops to the Float Transition Current setpoint if using IPN ProRemote).
	System shows Absorption (Acceptance) at times but battery voltage is low and current is very high near max. rating.	Normal operation. If the unit enters current limit, it will pass through Absorption (Acceptance) for about 10 seconds upon exiting current limit and returning to Bulk/MPPT.
Load control not working properly	Auxiliary output not set for load control	Confirm dip switch #4 is ON.
	Output may have shut off due to low battery charge	Load will shut off if battery voltage drops below OFF threshold (default 11.5/23.0 V). Once shut off, the load will turn on until battery voltage is above ON threshold (default 12.6/25.2 V).
	ON/OFF thresholds set to inappropriate values	Correct settings.
	Dusk-to-Dawn feature enabled	Disable Dusk-to-Dawn control.
Dusk-to-Dawn feature, lights will not turn ON or remain ON	Auxiliary output not set for load control	Confirm dip switch #4 is ON and Dusk-to-Dawn enabled.
	Output may have shut off due to low battery charge	Load will shut off if battery voltage drops below OFF threshold (default 11.5/23.0 V). Once shut off, the load will not come back on until battery voltage is above ON threshold (default 12.6/25.2 V).
	Charge control system ON	Lights will not turn on if charge control system is ON and charging.
	Timers set incorrectly	Check Post-Dusk and Pre-dawn timer settings
	First valid night time not seen yet	Pre-Dawn lighting will not operate until a valid night time of greater than 2 hours is detected to initialize the night time period.

Dusk-to-Dawn feature, lights will not turn OFF or remain OFF	Auxiliary output not set for load control	Confirm dip switch #4 is ON and Dusk-to-Dawn enabled.
	Dusk-to-Dawn feature not enabled.	Post-Dusk and Pre-dawn timers both set to DISABLED. One or both timers must be set to enable Dusk-to-Dawn feature.
	Timers set incorrectly	Correct Post-Dusk and Pre-dawn timer settings.
	Charge control does not turn ON	Check charge control operation
Networked units do not seem to coordinate action or followers do not turn on	IPN network address set wrong	A single unit must be set to IPN network address 0 (zero). One unit of a multi-unit network must be set to IPN network address 0 (zero), AND all other units must be set to different addresses.
	Network wiring problem	Confirm wiring. Use IPN ProRemote to View Charge Unit Status and confirm communication.
Temperature related functions do not work	Temperature sensor missing, failed or installed reverse polarity	If sensor is open, short, reverse polarity or missing unit will operate as if sensor was at 250 °C. Sensor voltage when connected should be 2.98 V at 250 °C, changing at +10 mV/0°C.
	Temperature sensor not installed on master	Temperature sensor must be installed on the master in a multi-controller system.
Display turns on, but battery voltage displays “---” rather than a number	Display not communicating with charge controller	Cable faulty
		One charge controller only must be Master.
		Poor or missing Bat – connections preventing communication
When charger turns on, output current displays “---” rather than a number	Output current display selection set for an address not present on the IPN network	Configure display IPN network address to a charger present on the IPN network.
Charge OFF at high ambient temperature	System temporarily shuts down due to high heat sink temperature	Improve ventilation or reduce PV (Panel) power. Sufficient ventilation to prevent over temperature shut down will improve reliability.
When charger turns on, output current displays but the value seems incorrect	Output current display selection set for wrong IPN network address	Configure display IPN network address DIP switch to read desired output current.
	Bat– connected to PV– outside charge controller	PV- & BAT- must be separate external to the unit for proper operation and cannot connect to a common location. External connection prevents proper operation of internal shunts and current measurement system.
Voltage or current value displayed seems to be stuck and does not change	Display or charge controller IPN network address has changed	Configure display IPN network address DIP switch to properly read output current of a charger present on the IPN network
	Display not communicating with charge controller	Intermittent display cable.

Specifications

	SB3024(D)iL @12 V	SB3024(D)iL @24 V
Max. Recommended Panel Power	540 W with 36-cell PV panel ⁽¹⁾	800 W with 72-cell PV panel ⁽¹⁾
	400 W with 60/72-cell PV panel ⁽¹⁾	
Rated Battery (Output) Current	40 A with 36-cell PV panel ⁽¹⁾	30 A with 72-cell PV panel ⁽¹⁾
	30 A with 60/72-cell PV panel ⁽¹⁾	
Conversion Efficiency	97% (typical @ 28 V / 24 A output)	
Power Consumption	0.35 W (typical standby)	
Max. Recommended Panel Voc at STC	45.6 V (Max Panel Input 57 V)	
Charge Profile	Multi-Stage plus Manual or Automatic Equalization	
Absorption Voltage	14.4 V ⁽²⁾	28.8 V ⁽²⁾
Float Voltage	13.2 V ⁽²⁾	26.4 V ⁽²⁾
Equalization Voltage (if enabled)	15.2 V ⁽²⁾	30.4 V ⁽²⁾
Min. Battery Voltage for Operation	9 V	
Auxiliary Output (option A, B, or C)	A) Auxiliary 2 A Battery Charge (2nd battery)	
	B) Load Control w/LVD	
	C) Dusk-to-Dawn w/LVD (by IPN ProRemote, BT Connect)	
Load (LVD) Disconnect/Reconnect Voltage	11.5 V / 12.6 V ⁽²⁾	23.0 V / 25.2 V ⁽²⁾
Maximum Auxiliary Output current (option B or C)	20 A	
Display	Only version SB3024DiL	
Temperature Compensation (by optional Battery Temp. Sensor)	-5.00 mV/°C/cell correct factor (Range 0.00 to -8.00 mV/°C/cell) ⁽²⁾	
Operating Temperature	-40 °C – 40 °C	
Maximum Full Power Ambient	40 °C	
Environmental Protection	IP 20	
Weight	3.95 lb (1.8 Kg)	
Dimensions	6.86 x 6.6 x 3.38" (17.4 x 16.8 x 8.6 cm)	

(1) 36-cell panels are typically referred to as "12 V panels" providing V_{mp}/V_{oc} of ~18 V / 22 V at STC, 60-cell panels refers to "20 V panels" (V_{mp}/V_{oc} ~30 V / 37 V), 72-cell panels refers to "24 V panels" (V_{mp}/V_{oc} ~36 V / 44 V).

(2) Factory default voltages unless programmed via DIP switches or with IPN ProRemote, ProTouch, BT Connect, or UCM.

5 year limited warranty

Visit [https://sunforgellc.com/product/sb3024\(d\)il/](https://sunforgellc.com/product/sb3024(d)il/) for more information and terms of the warranty.

Copyright © 2022 Sunforge LLC. All rights reserved. Changes are periodically made to the information herein which will be incorporated in revised editions of this publication. Sunforge may make changes or improvements to the product(s) described in this publication at any time and without notice.